

# New Product Update

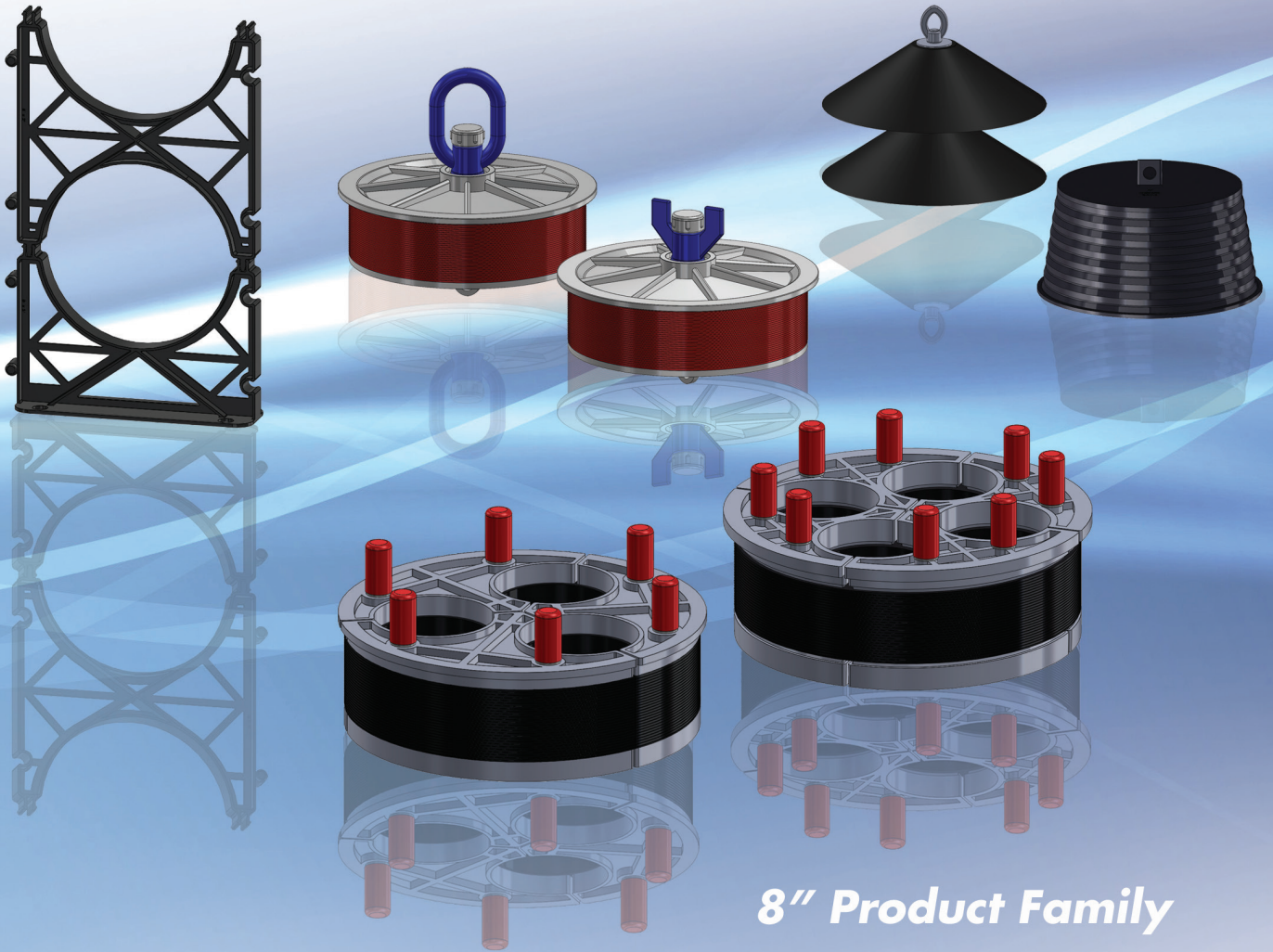

**8" Product Family**



*Underground Electrical & Broadband Fittings*

# 8" Duct Spacers

8"x 2" & 8"x 3"

Cal Am Manufacturing's Hi-Impact Utility Duct Spacers have been the choice for contractors for nearly three decades; utilizing a proven two-piece design specifically engineered to support duct arrays within trenching prior to encasement, these sturdy, versatile and light-weight spacers will not shift under the weight of your workmen and stay firmly in place during fill.

- Resistant to Extreme Temperature Fluctuations
- Constructed of High Impact Polymers
- Snap-Loc Design for Fast Field Assembly
- Virtually Indestructible Proven Design
- No Banding Required

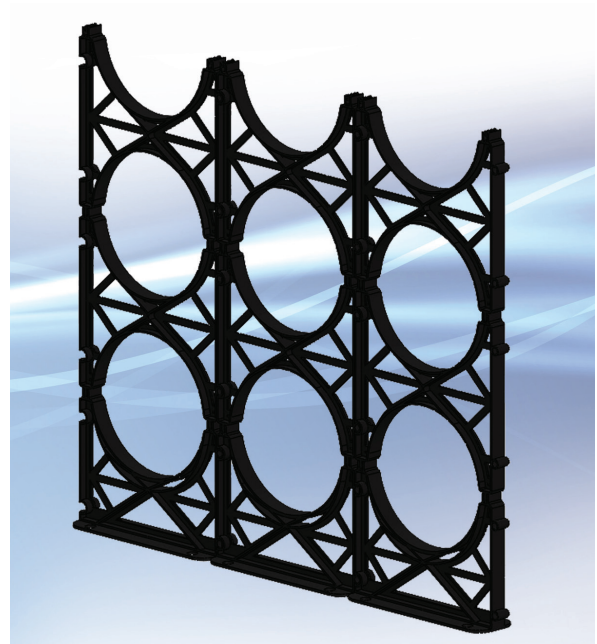

## 8"x 2" Duct Spacers

Ordering Information:

### Base Spacer

Catalog no. [4080-20](#)

Units Per Case: 65

### Inter Spacer

Catalog no. [4180-20](#)

Units Per Case: 70

## 8"x 3" Duct Spacers

Ordering Information:

### Base Spacer

Catalog no. [4080-30](#)

Units Per Case: 60

### Inter Spacer

Catalog no. [4180-30](#)

Units Per Case: 45

# 8" Wedge Seals™

# 3-WAY & 4-WAY

Cal Am Wedge Seals provide a quick and easy-to-use system to protect and organize ducts and cables for fiber optic, telecommunications and electrical applications.

- Rain-proof protection
- Easy to install
- Secure installation
- Prevents dirt, dust and animal intrusion
- Corrosion proof, recyclable materials
- Protects and organizes
- Long term use
- Eliminate duct-edge abrasion to cables

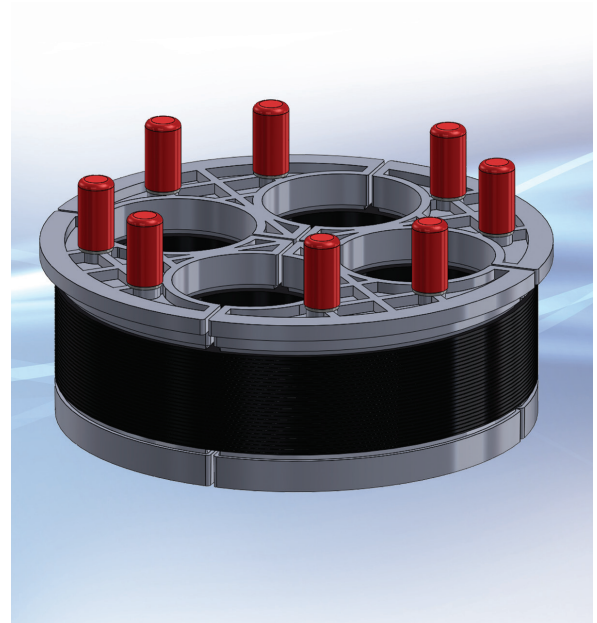
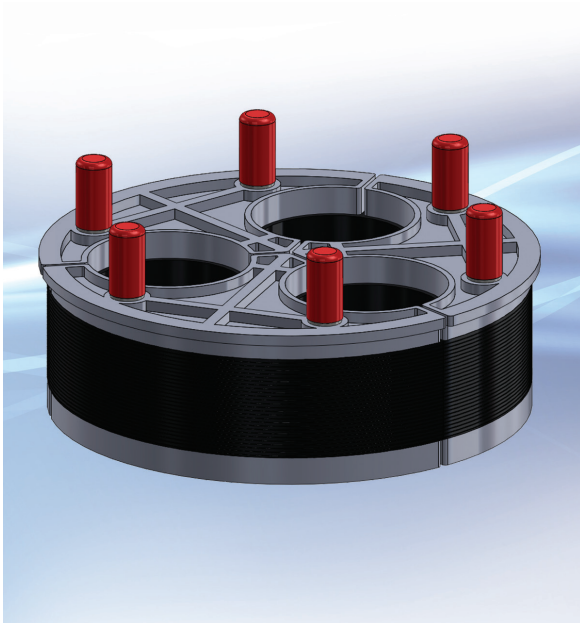

## Wedge Seal™ 3-WAY

Ordering Information:

Size: 8" SCH. 40 Conduit

Catalog no. [7380-XXXX](#)

Units: 1 each

## Wedge Seal™ 4-WAY

Ordering Information:

Size: 8" SCH. 40 Conduit

Catalog no. [7480-XXXX](#)

Units: 1 each

# 8" Mechanical Plugs

The original Kwikie brand mechanical plug is one of Cal Am Manufacturing's most popular products. Trusted by contractors world-wide to secure their conduit systems from the costly and often damaging incursion of water sedimentation and nesting animals, these high quality plugs are manufactured from a trio of hi-impact chemically inert resins that will also confine volatile and hazardous vapors to their source.

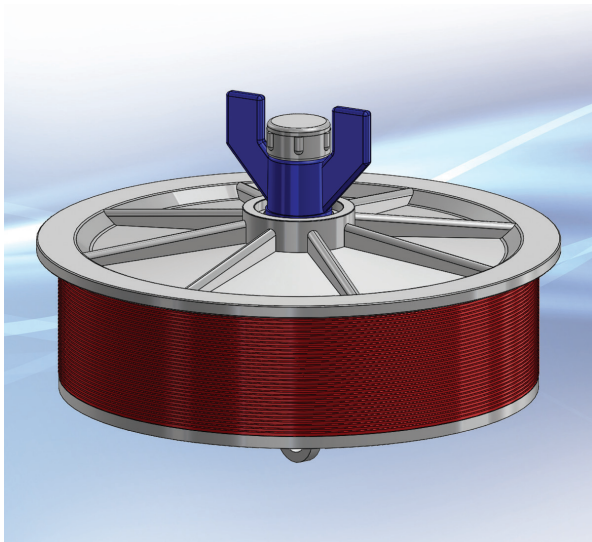

## 8" Kwikie™ Mechanical Plug Wing Nut

### Ordering Information:

Size: 8"

Catalog no. [5120-80](#)

Units Per Case: 12

# Wing Nut & Loop Nut

- Corrosion Proof
- Gas & Water Tight
- Debris & Animal Secure
- Removable & Reusable

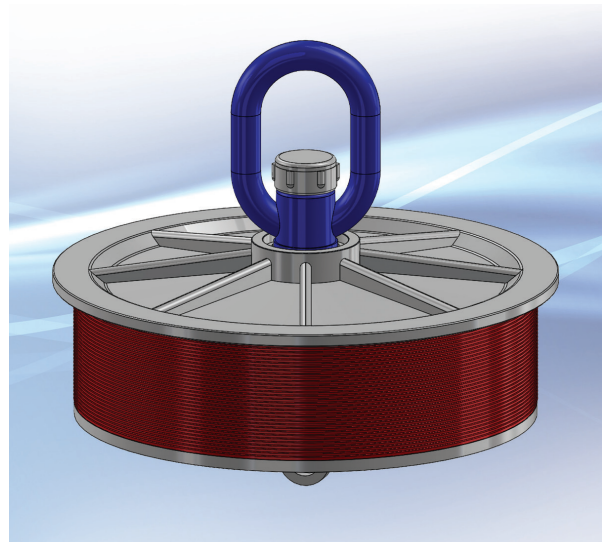

## 8" Kwikie™ Mechanical Plug Loop Nut

### Ordering Information:

Size: 8"

Catalog no. [5120-80L](#)

Units Per Case: 12

# 8" Cal Missile™

Cal Am Manufacturing's "Cal Missile" is the Cadillac of all missile line carriers; Constructed with heavy-duty stainless steel hardware and Polyurethane blow cups, this ultra-tough projectile will perform flawlessly time and time again.

- Ultra Tough and Re-usable
- Fast Blowing, Low Friction
- For Use with Duct and Inner Duct
- Tear Resistant



## 8" Cal Missile™

Ordering Information:

Size: 8"

Catalog no. [2110-080](#)

Units Per Case: 1

<http://calammfg.com/>

# 8" Poly-Pull Plug™

Cal Am's Poly-Pull brand temporary duct plugs are designed for the interim sealing of standard duct and terminators from the damaging and expensive effects of weather, job site debris and animal incursion.

- Tapered, Ribbed Side Walls  
Ensure Tight Seal
- Extended Base-lip for Easy  
Removal
- Maintains Shape in Extreme  
Environments

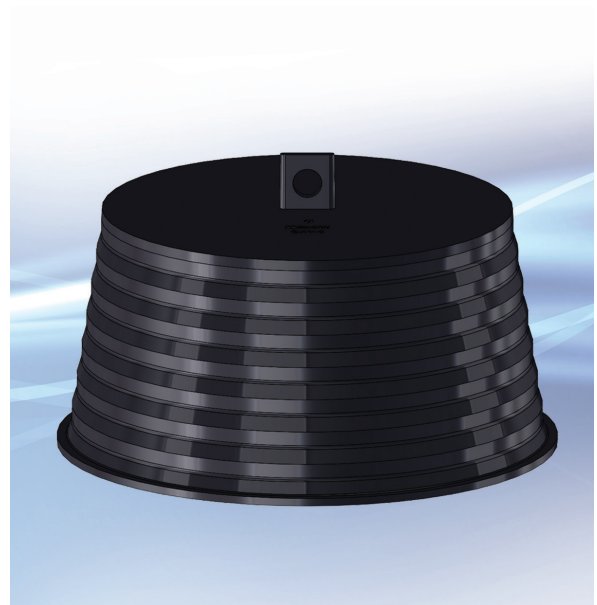

## 8" Poly-Pull Plug™

Ordering Information:

Size: 8"

Catalog no. [2250-080](#)

Units Per Case: 12

Toll Free 800-992-0499



Phone/Fax

800-992-0499 Toll Free

619-336-9550 Phone

619-336-9549 Fax

Email

[sales@calammfg.com](mailto:sales@calammfg.com)

Visit us Online

<http://calammfg.com/>