

CONDUIT ID RANGE	APPLICABLE 5" [125mm] CONDUIT	PORT RANGE
4.95" - 5.15" [125.73mm - 130.81mm]	PVC SCH 40 HDPE SCH 40 F2160	1.18" - 1.22" [29.97mm - 30.98mm]

Applicable conduit types based on product's conduit ID range meeting or exceeding conduit ID dimensions specified in one or more of following standards: UL651, UL651A, ASTM F2160, NEMA TC 6 & 8

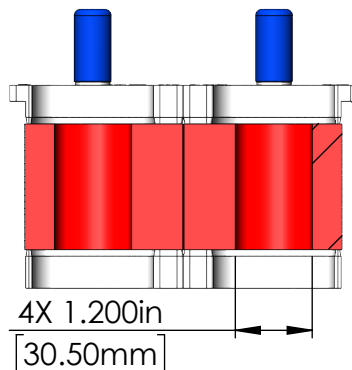

SECTION E-E
SCALE 1 : 3

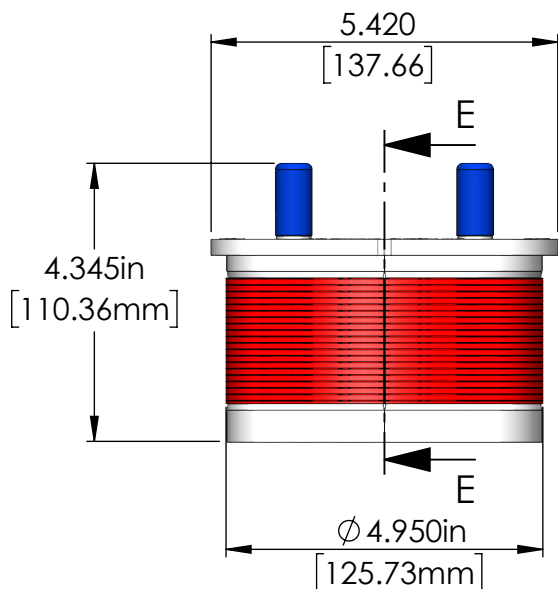
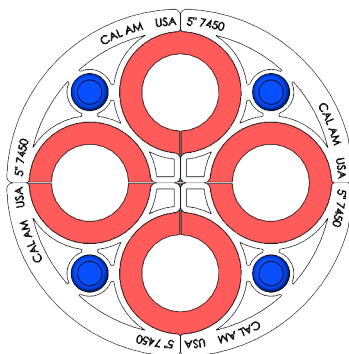
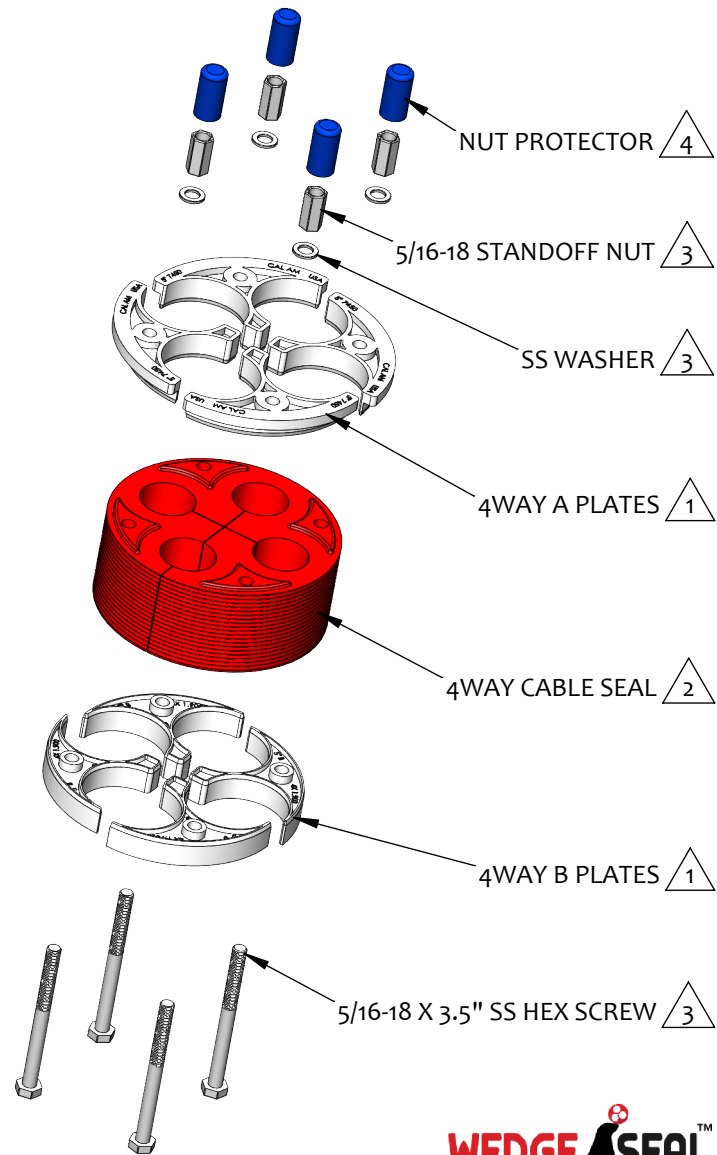

NOTES:

- 1 Material: PVC
- 2 Material: TPE
- 3 Material: Stainless Steel
- 4 Material: Vinyl

TITLE	QUADPLEX ENTRY SEAL, 5.00" 125mm, PORT 1.20" 30mm		
PROPRIETARY AND CONFIDENTIAL THE INFORMATION CONTAINED IN THIS DRAWING IS THE SOLE PROPERTY OF CAL AM MANUFACTURING. ANY REPRODUCTION IN PART OR AS A WHOLE WITHOUT THE WRITTEN PERMISSION OF CAL AM MANUFACTURING IS PROHIBITED.	DRAWN	JC. MORENO	DATE : 11/07/2024
	DRAWING NO.	7450-120	UNLESS OTHERWISE SPECIFIED DIMENSIONS ARE IN INCHES TOLERANCES: X±0.1 X.X±0.05 X.XX±0.030 X.XXX±0.020
	REVISION	B	
	SCALE:	1:3	PRODUCT NUMBER:



SHEET 1 OF 1