

CONDUIT ID RANGE	APPLICABLE 5" [125mm] CONDUIT	PORT RANGE
4.95" - 5.15" [125.73mm - 130.81mm]	PVC SCH 40 HDPE SCH 40 F2160	1.23" - 1.32" [31.24mm - 33.52mm]

Applicable conduit types based on product's conduit ID range meeting or exceeding conduit ID dimensions specified in one or more of following standards: UL651, UL651A, ASTM F2160, NEMA TC 6 & 8

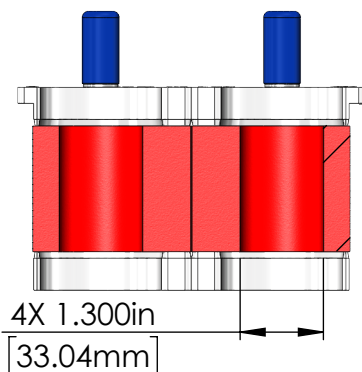

SECTION E-E  
SCALE 1 : 3

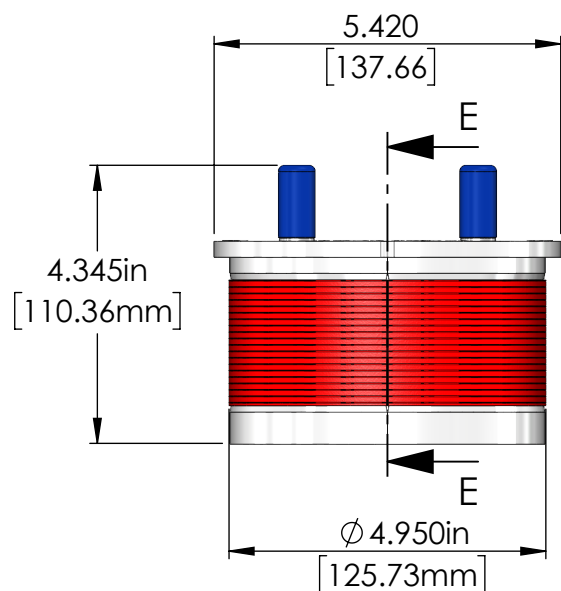
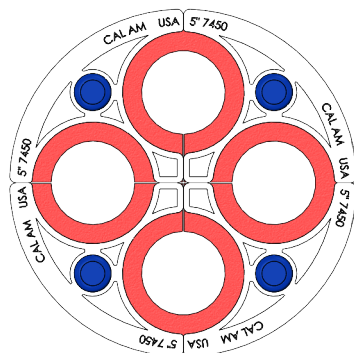
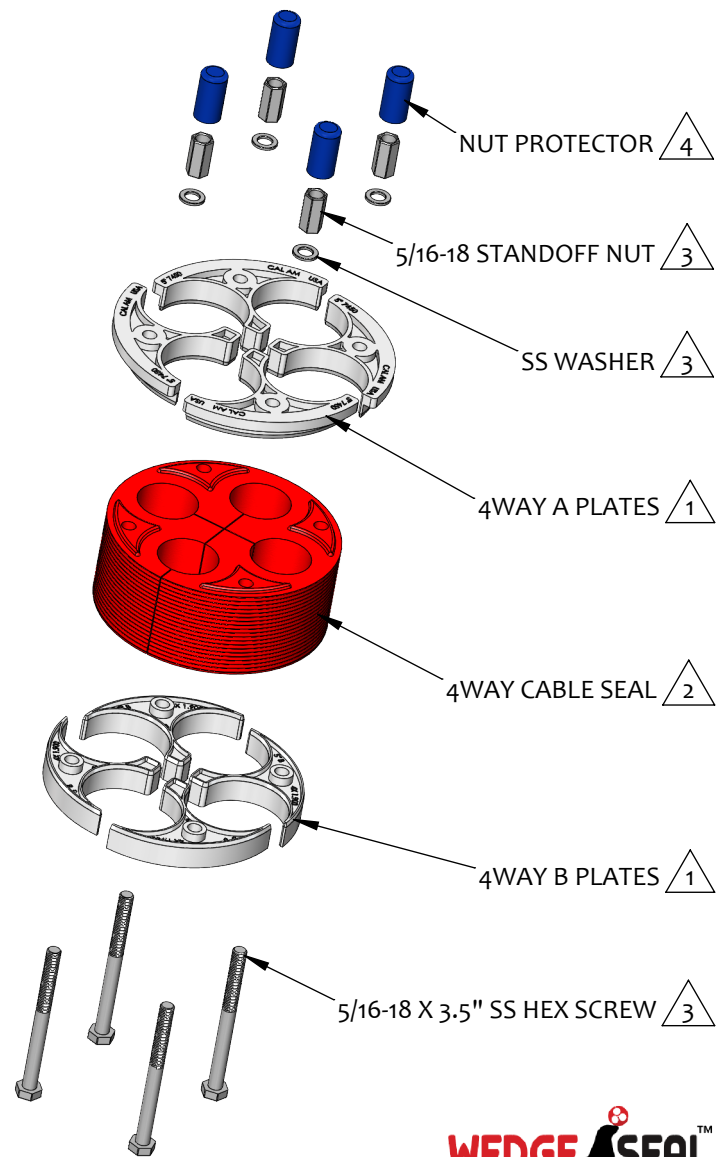

NOTES:

- 1 Material: PVC
- 2 Material: TPE
- 3 Material: Stainless Steel
- 4 Material: Vinyl

TITLE	QUADPLEX ENTRY SEAL, 5.00"   125mm, PORT 1.30"   33mm		
<b>PROPRIETARY AND CONFIDENTIAL</b> THE INFORMATION CONTAINED IN THIS DRAWING IS THE SOLE PROPERTY OF CAL AM MANUFACTURING. ANY REPRODUCTION IN PART OR AS A WHOLE WITHOUT THE WRITTEN PERMISSION OF CAL AM MANUFACTURING IS PROHIBITED.	DRAWN	JC. MORENO	DATE : 11/07/2024
	DRAWING NO.	7450-130	UNLESS OTHERWISE SPECIFIED DIMENSIONS ARE IN INCHES TOLERANCES: X±0.1 X.X±0.05 X.XX±0.030 X.XXX±0.020
	REVISION	B	
	SCALE:	1:3	PRODUCT NUMBER:



SHEET 1 OF 1