

## KEY FEATURES AND BENEFITS

- When the thermoplastic elastomer gasket is expanded, it creates a water, air, and rodent-resistant seal – protecting the conduit from damaging environmental conditions
- Constructed of non-metallic, corrosion-resistant materials for a long-lasting and cost-effective plug
- Requires no additional tools for quick and easy installation
- Install in PVC, HDPE, EMT, and corrugated conduit for versatility
- Two rope-tie points built into the plug for installation with mule tape or pull line for a secure seal

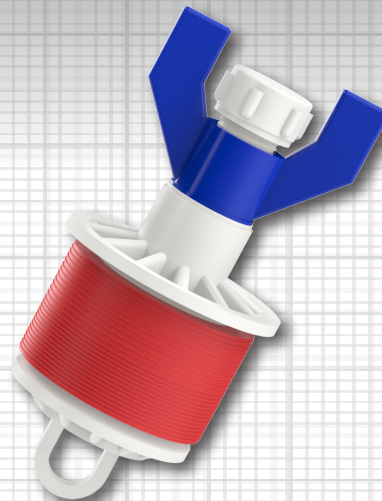

Loop Nut



Wing Nut

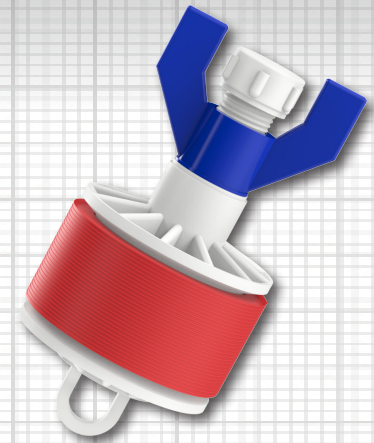

Inside Fit

**Kwikie**<sup>®</sup>  
Blank Duct Plugs

## Three styles to effectively seal a variety of blank conduit

The #1 trusted brand in blank duct plugs, the Kwikie<sup>®</sup> is essential to any datacenter, telecom, or underground electrical project. This is because the proper sealing of conduits and innerduct is vital for protecting infrastructure investment and, in many cases, required by code. After decades of use in the field by telecom and electrical professionals, the Kwikie has become an indispensable industry standard, and its usage continues to grow worldwide.

The plugs install tightly into conduit, creating a secure seal from unwanted water, sediment, or animal intrusion. A variety of sizes are available for various conduit dimensions and types, as they are compatible with HDPE, PVC, corrugated conduit, and EMT. Installation of the plugs is quick and easy, with no tools required for installation or removal.

There are three styles of Kwikie plugs available:

- Loop Nut – An additional tie point making the plug installable from both sides of the conduit
- Wing Nut – Smaller in height than the loop nut, allowing installation in tighter spaces
- Inside Fit – Can be installed entirely inside the conduit and out of sight from the outside; available in either loop nut or wing nut

While there are other methods of sealing conduit, they are costly, unprofessional, and time-consuming. For the highest quality and performance, the Kwikie is the top choice for datacenters that demand the best in blank duct plugs.

Visit [CalAm.net](https://calam.net)

<https://calam.net/electrical-broadband/mechanical-plugs/>

## ADDITIONAL PRODUCT INFORMATION



Designed to seal:



SCH 40  
PVC



HDPE



EMT

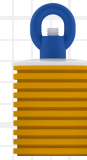

Corrugated  
Duct



SCH 80  
PVC

### PRIMARY CUSTOMER

- Datacenter
- Telecommunications
- Electrical

### JOBSITE APPLICATIONS

- Sealing & Termination
- Long-term Operation

### TYPICAL PROJECT PHASES

- Direct Burial
- Duct Bank
- Vaults
- Manholes
- Wall Entrances

### FIELD USE

Seals unused conduit against air, water, rodents and dirt.

Not sure which size you need?  
Find it fast with our Kwikie® Lookup Tool.



<https://calam.net/blank-duct-plug-look-up/>

Trusted in datacenters by:



Scan here to order FREE samples!

Visit CalAm.net  
<https://calam.net/electrical-broadband/mechanical-plugs/>

## SPECIFICATIONS

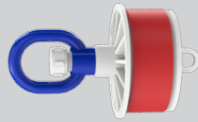
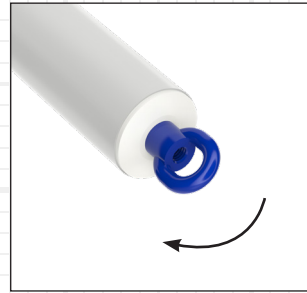
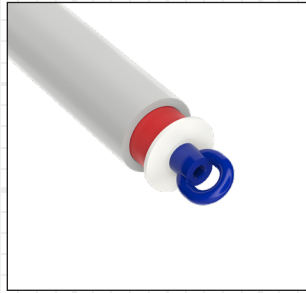
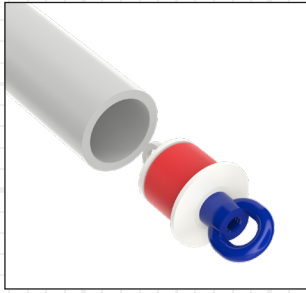

**LOOP NUT**

PRODUCT NUMBER	JACKMOON® CROSS REFERENCE NUMBER	EACH SIZE (IN)	EACH SIZE (mm)	UNIT OF MEASURE	CASE QUANTITY	CONDUIT INNER DIAMETER (IN)	CONDUIT INNER DIAMETER (mm)
5120-07	JM-BLA-07D100U	0.75	20	Case	50	0.766 - 1.020	19.46 - 25.91
5120-10	JM-BLA-10D104U	1.00	25	Case	50	0.994 - 1.390	25.25 - 35.31
5120-12	JM-BLA-12D148U	1.25	32	Case	50	1.156 - 1.510	29.36 - 38.35
5120-15	JM-BLA-15D183U	1.50	40	Case	50	1.460 - 1.830	37.08 - 46.48
5120-20	JM-BLA-20D236U	2.00	50	Case	50	1.834 - 2.386	46.58 - 60.60
5120-25L	JM-BLA-25D296U	2.50	65	Case	30	2.400 - 2.990	60.96 - 75.95
5120-30L	JM-BLA-30D346U	3.00	80	Case	30	2.920 - 3.450	74.17 - 87.63
5120-35L	JM-BLA-35D400U	3.50	90	Case	30	3.410 - 3.900	86.61 - 99.06
5120-40L	JM-BLA-40D402U	4.00	100	Case	30	3.940 - 4.330	100.08 - 109.98
5120-50L	JM-BLA-50D535U	5.00	125	Case	20	4.850 - 5.250	123.19 - 133.35
5120-58L	JM-BLA-50D500U	5.00	125	Case	20	4.675 - 5.250	118.75 - 133.35
5120-60L	JM-BLA-60D637U	6.00	150	Case	20	5.920 - 6.375	152.15 - 161.93
5120-68L		6.00	150	Case	20	5.490 - 5.940	139.45 - 150.88
5120-80L	JM-BLA-80D816U	8.00	200	Case	12	7.810 - 8.250	198.37 - 209.55



Scan here to order FREE samples!

Visit CalAm.net  
<https://calam.net/electrical-broadband/mechanical-plugs/>

## SPECIFICATIONS

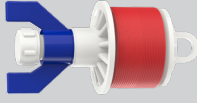
PRODUCT NUMBER	JACKMOON® CROSS REFERENCE NUMBER	EACH SIZE (IN)	EACH SIZE (mm)	UNIT OF MEASURE	CASE QUANTITY	CONDUIT INNER DIAMETER (IN)	CONDUIT INNER DIAMETER (mm)
 <b>WING NUT</b>							
5120-25	JM-BLA-25D296U	2.50	65	Case	30	2.400 - 2.990	60.96 - 75.95
5120-30	JM-BLA-30D346U	3.00	80	Case	30	2.920 - 3.450	74.17 - 87.63
5120-35	JM-BLA-35D400U	3.50	90	Case	30	3.410 - 3.900	86.61 - 99.06
5120-40	JM-BLA-40D402U	4.00	100	Case	30	3.940 - 4.330	100.08 - 109.98
5120-50	JM-BLA-50D535U	5.00	125	Case	20	4.850 - 5.250	123.19 - 133.35
5120-58	JM-BLA-50D500U	5.00	125	Case	20	4.675 - 5.250	118.75 - 133.35
5120-60	JM-BLA-60D637U	6.00	150	Case	20	5.920 - 6.375	150.37 - 161.93
5120-68		6.00	150	Case	20	5.490 - 5.940	139.45 - 150.88
5120-80	JM-BLA-80D816U	8.00	200	Case	12	7.810 - 8.250	198.37 - 209.55



Scan here to order FREE samples!

Visit CalAm.net  
<https://calam.net/electrical-broadband/mechanical-plugs/>

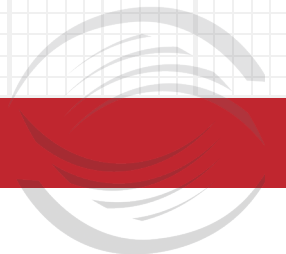

## SPECIFICATIONS

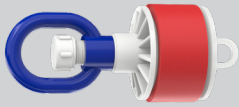
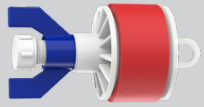
PRODUCT NUMBER	TYPE	EACH SIZE (IN)	EACH SIZE (mm)	UNIT OF MEASURE	CASE QUANTITY	CONDUIT INNER DIAMETER (IN)	CONDUIT INNER DIAMETER (mm)	
		<b>INSIDE FIT - LOOP NUT OR WING NUT</b>						
5120-15P	LOOP NUT	1.50	40	Case	50	1.460 - 1.830	37.08 - 46.48	
5120-20P	LOOP NUT	2.00	50	Case	50	1.834 - 2.386	46.58 - 60.60	
5120-30PL	LOOP NUT	3.00	80	Case	30	2.920 - 3.450	74.17 - 87.63	
5120-30P	WING NUT	3.00	80	Case	30	2.920 - 3.450	74.17 - 87.63	
5120-40PL	LOOP NUT	4.00	100	Case	30	3.940 - 4.330	100.08 - 109.98	
5120-40P	WING NUT	4.00	100	Case	30	3.940 - 4.330	100.08 - 109.98	
5120-50PL	LOOP NUT	5.00	125	Case	20	4.850 - 5.250	123.19 - 133.35	
5120-50P	WING NUT	5.00	125	Case	20	4.850 - 5.250	123.19 - 133.35	
5120-60PL	LOOP NUT	6.00	150	Case	20	5.920 - 6.375	150.37 - 161.93	
5120-60P	WING NUT	6.00	150	Case	20	5.920 - 6.375	150.37 - 161.93	

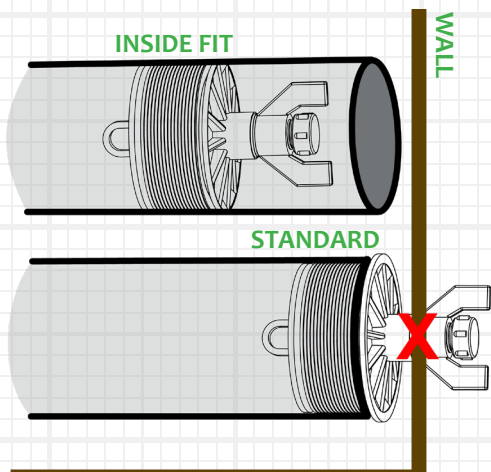

### What is it:

The inside fit Kwikie® installs completely inside the conduit, not at the opening and the entire plug is not visible at the duct face after installation.

### Specifically designed for applications where:

- A flush exterior finish is required
- Space is limited at the end of the conduit



Scan here to order FREE samples!

Visit CalAm.net  
<https://calam.net/electrical-broadband/mechanical-plugs/>

## APPLICABLE CONDUIT

Look up the corresponding Kwikie® plug per conduit type in the table below.

NOTE: Empty boxes indicate that the conduit is not made in that dimension.

PRODUCT NUMBER	CONDUIT SIZE	SCH40	SCH80	DB60	DB100	DB120	EMT	SDR9	SDR11	SDR13.5	SDR15.5	SDR17
Not available	0.50" [12.7mm]	X	X				X			X		
5120-07	0.75" [19.1mm]	✓	X				✓		✓	✓	✓	
5120-10	1.00" [25.4mm]	✓	*5120-07			✓	✓	✓	✓	✓	✓	✓
5120-12	1.25" [31.8mm]	✓	✓				✓	✓	✓	✓	✓	✓
5120-15	1.50" [38.1mm]	✓	✓			✓	✓	*5120-12	✓	✓	✓	
5120-20	2.00" [50.8mm]	✓	✓	✓		✓	✓	*5120-15	✓	✓	✓	
5120-25L	2.50" [63.5mm]	✓	*5120-20				✓					
5120-30L	3.00" [76.2mm]	✓	*5120-25L	✓	✓	✓	✓	*5120-25L	*5120-25L	✓	✓	
5120-35L	3.50" [88.9mm]	✓	*5120-30L				✓					
5120-40L	4.00" [101.6mm]	✓	*5120-35L	✓	✓	✓	✓	*5120-35L	*5120-35L	*5120-35L	*5120-35L	
5120-50L	5.00" [127mm]	✓	*5120-58L	X	✓	✓						
5120-58L	5.00" [127mm]	✓	✓	✓	✓	✓					✓	
5120-60L	6.00" [152.4mm]	✓	X	✓	✓	✓						
5120-68L	6.00" [150mm]		✓							✓	✓	
5120-80L	8.00" [203.2mm]	✓										

\* Cal Am product size required is different than trade size of conduit.

Applicable conduit types based on product's expansion range meeting or exceeding conduit average ID dimensions specified in one or more of following standards: UL651, UL651A, ASTM F2160, NEMA TC 6 & 8

For more technical information and/or to download the Tech Sheet for these products, please visit the Product Webpage: <https://calam.net/electrical-broadband/mechanical-plugs/>



Scan here to order FREE samples!

Visit CalAm.net  
<https://calam.net/electrical-broadband/mechanical-plugs/>

## PSI/BAR RATINGS

PRODUCT NUMBER	WATER/ AIR PSI	WATER/ AIR BAR
5120-07	48	3.3
5120-10	48	3.3
5120-12	48	3.3
5120-15	32	2.2
5120-20	32	2.2
5120-25L	32	2.2
5120-30L	24	1.7
5120-35L	24	1.7
5120-40L	24	1.7
5120-50L	16	1.1
5120-58L	16	1.1
5120-60L	16	1.1
5120-68L	16	1.1
5120-80L	16	1.1

PRODUCT NUMBER	WATER/ AIR PSI	WATER/ AIR BAR
5120-25	32	2.2
5120-30	24	1.7
5120-35	24	1.7
5120-40	24	1.7
5120-50	16	1.1
5120-58	16	1.1
5120-60	16	1.1
5120-68	16	1.1
5120-80	16	1.1

PRODUCT NUMBER	WATER/ AIR PSI	WATER/ AIR BAR
5120-15P	32	2.2
5120-20P	32	2.2
5120-30PL	24	1.7
5120-30p	24	1.7
5120-40PL	24	1.7
5120-40P	24	1.7
5120-50PL	16	1.1
5120-50P	16	1.1
5120-60PL	16	1.1
5120-60P	16	1.1



### ABOUT CAL AM MANUFACTURING

Cal Am Manufacturing® specializes in products for use in underground electrical and broadband applications. Founded in Southern California over thirty-five years ago, Cal Am designs and produces fittings and sealing devices to serve utilities, municipalities, government facilities, data centers, and fiber optic projects, through a worldwide network of distributors.



Scan here to order FREE samples!



Corporate Office:  
El Cajon, CA 92020

Phone +1.619.336.9550

sales@calam.net  
marketing@calam.net  
accounting@calam.net

www.CalAm.net